

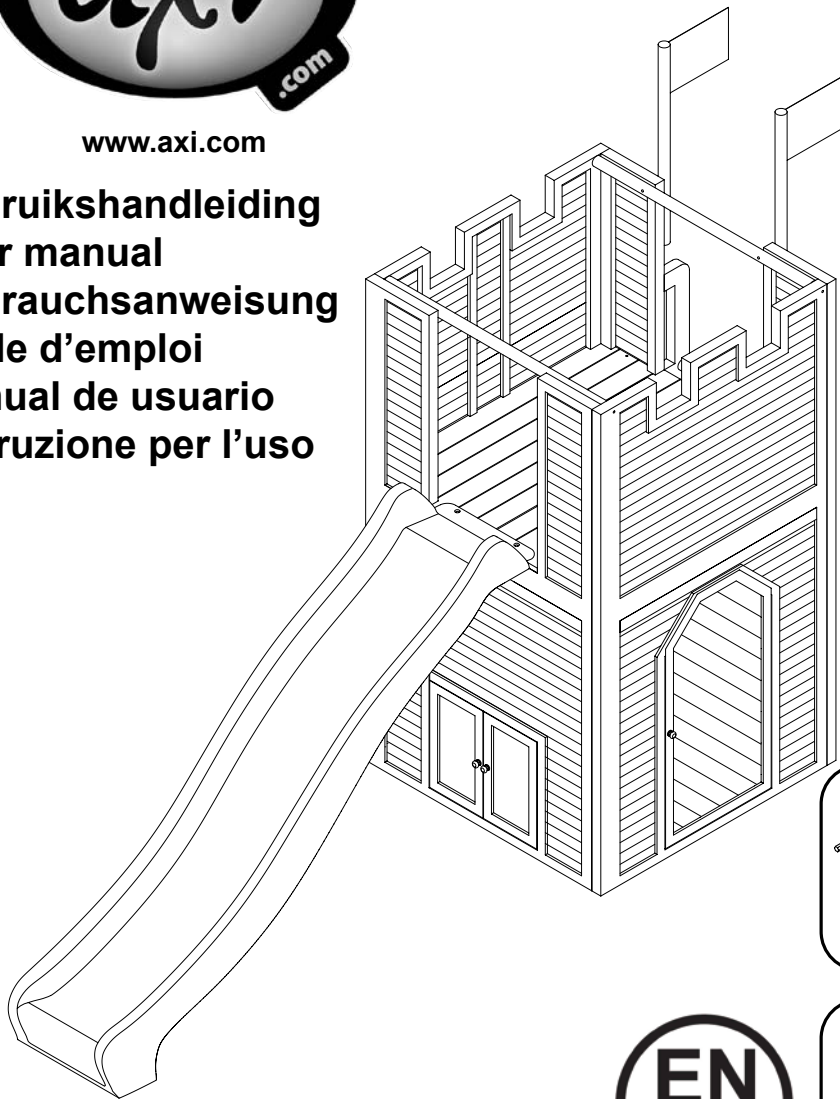

www.axi.com

AXI.COM Wooden playhouse Arthur

Gebruikshandleiding
User manual
Gebrauchsanweisung
Mode d'emploi
Manual de usuario
Istruzione per l'uso



AXI 06

patented product

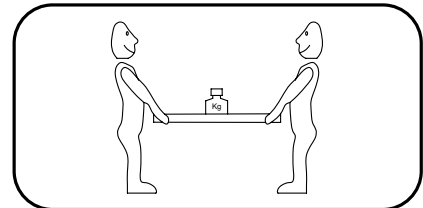
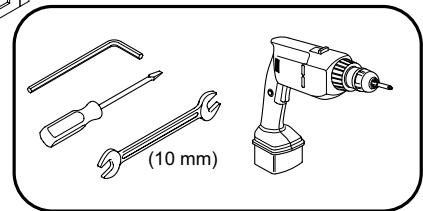

Handleiding bewaren voor later gebruik
Keep instructions for later use
Anleitung zum späteren Gebrauch aufbewahren
Conserver la notice pour usage ultérieur
Guardar estas Instrucciones para su uso future
Conservare l'istruzioni per uso successivo

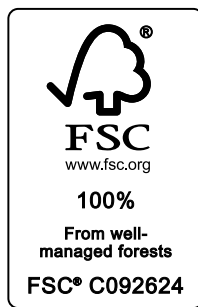
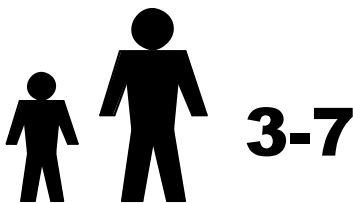

WARNING

CHOKING HAZARD
small parts

Not suitable for children under 36 months



WARNING

THE TOY IS TO BE ASSEMBLED BY AN ADULT.



WARNING

Potential hazard description, e.g. In unassembled state contain potentially hazardous sharp points, so please keep out of baby's reach



Arthur

A030.124.00

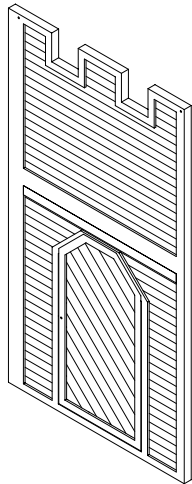

5

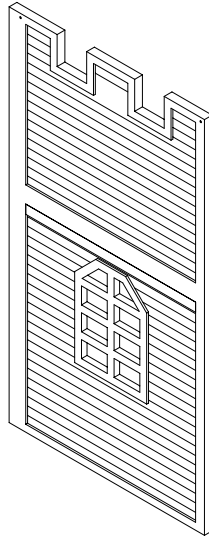

6

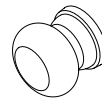

9

6x

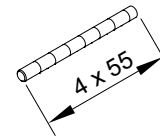

t1

3x

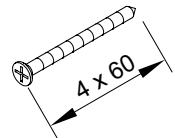

s2

20x

A030.125.00

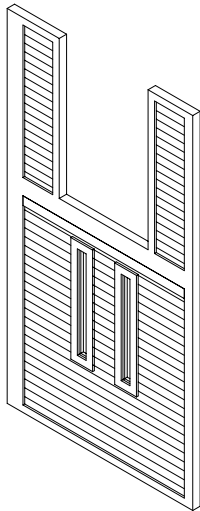

4

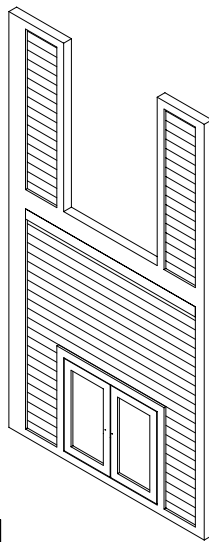

8

A030.033.00

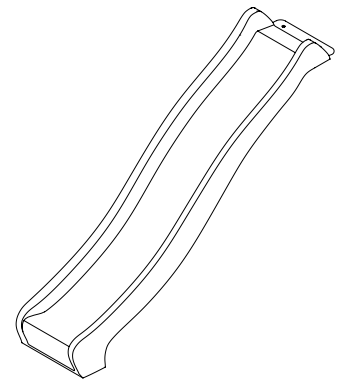

11

A030.126.00



1



2

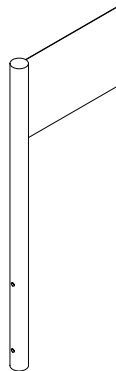

13

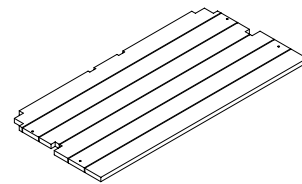

10

2x

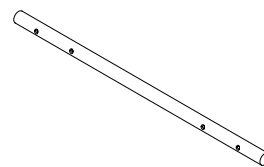

12

2x

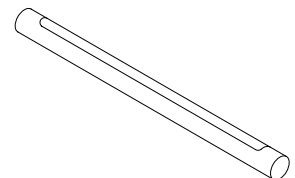

3

4x

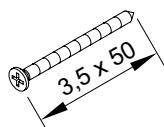

s1

16x

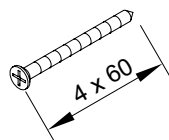

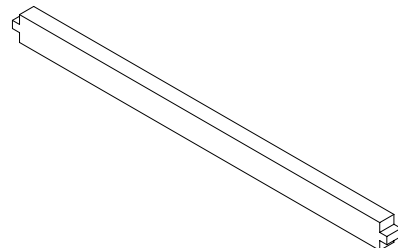

s2

20x

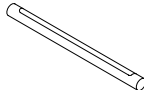
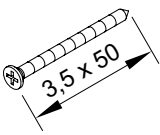

7

 1	 2	 3 4x	 s1 8x	
--	--	---	---	--

A030.126.00

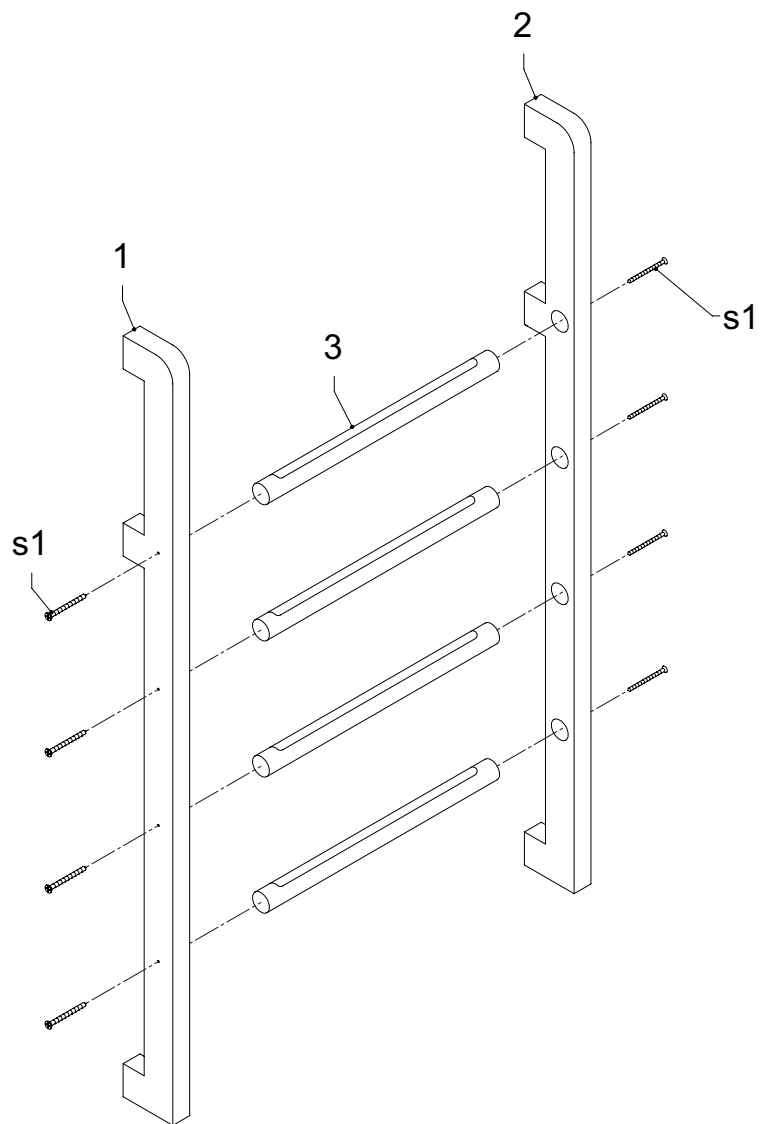

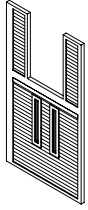

4

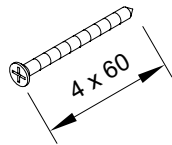



s2

6x

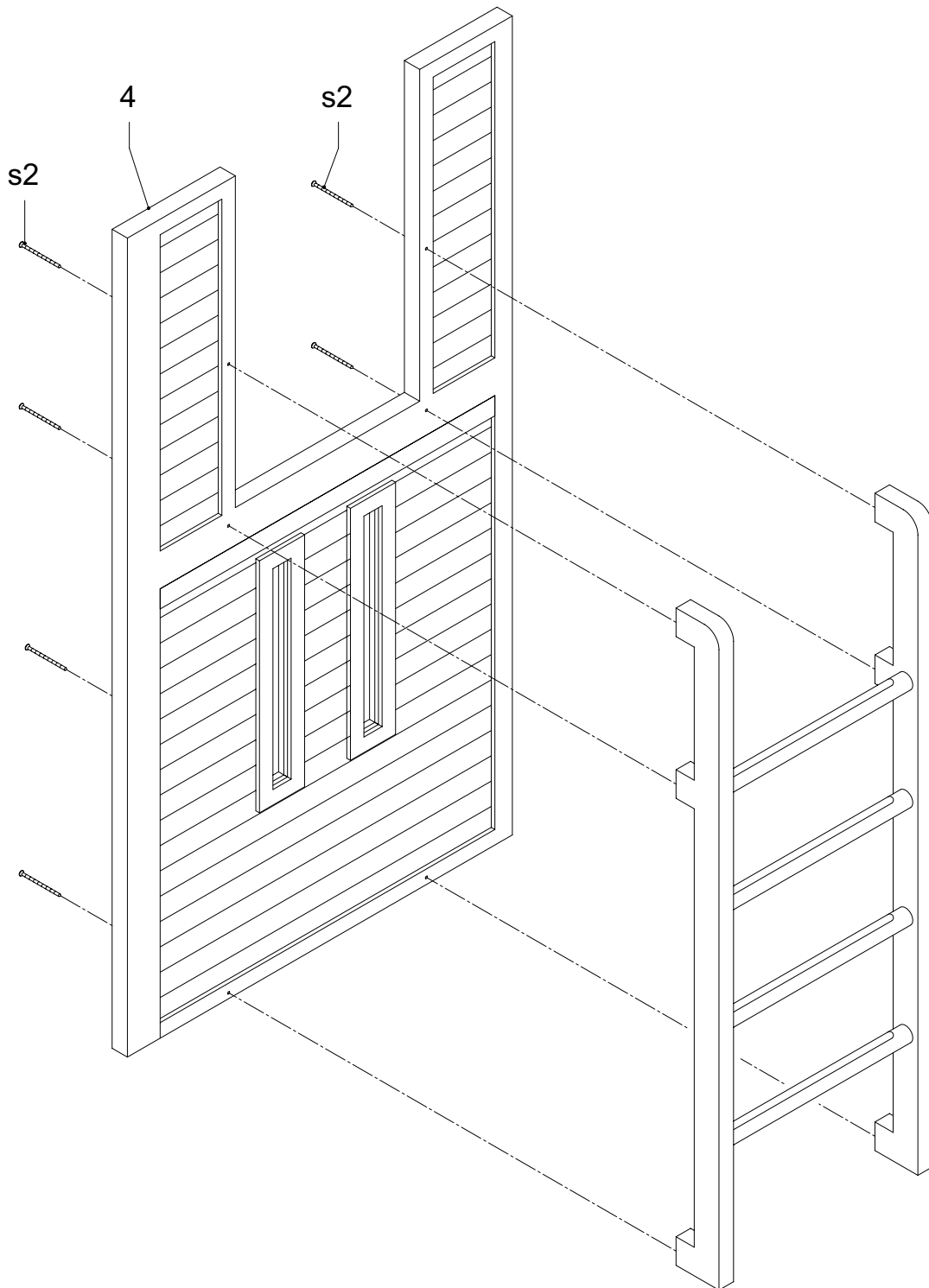
A030.125.00 + A030.126.00

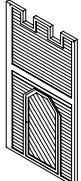
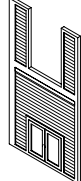

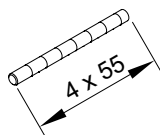
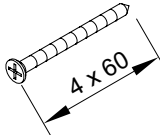
 5	 8	 9 6x	 t1 3x	 s2 5x
--	--	--	---	---

A030.125.00

Detail A

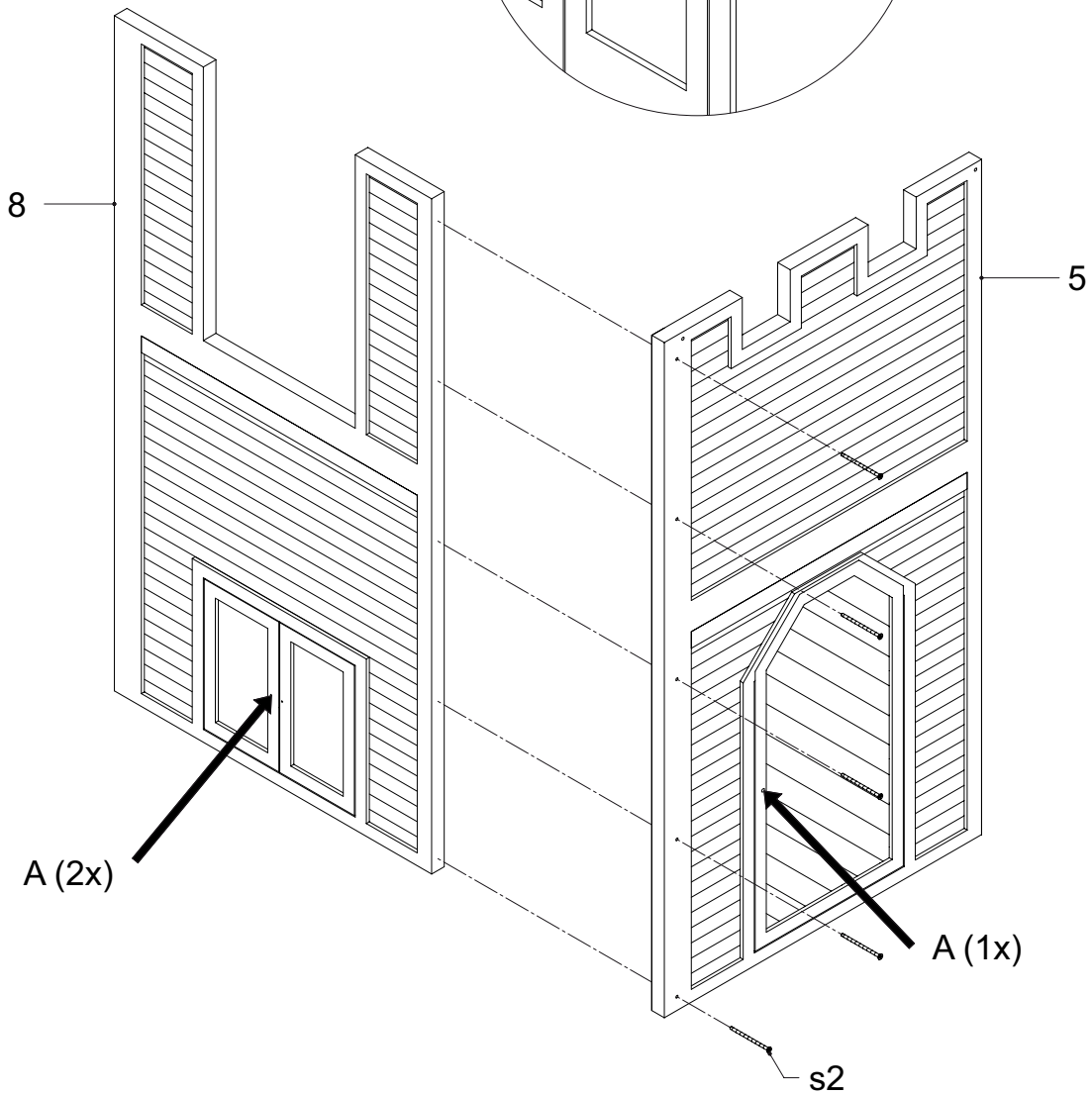
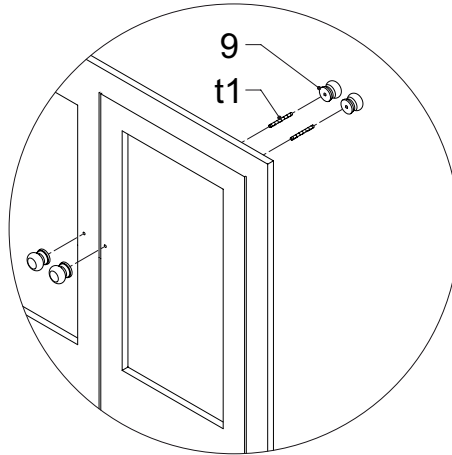

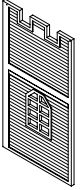
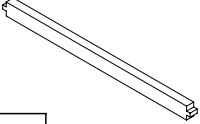
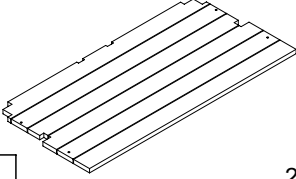
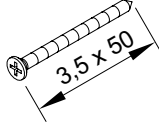
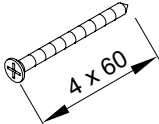
					
6	7	10	2x s1	4x s2	5x

A030.124.00 + A030.126.00

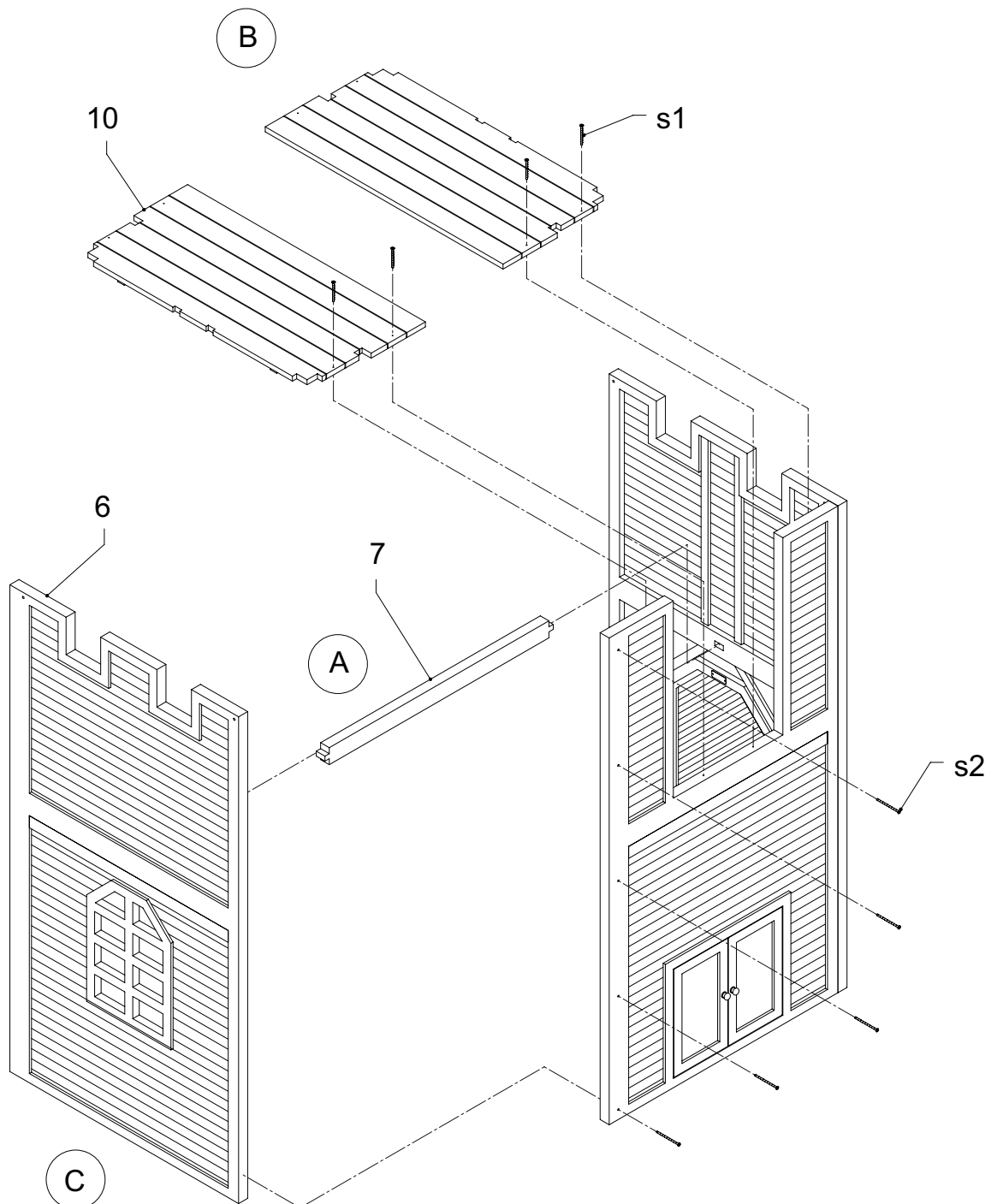

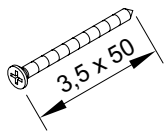

s1

4x

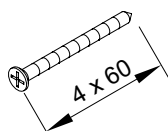



s2

10x

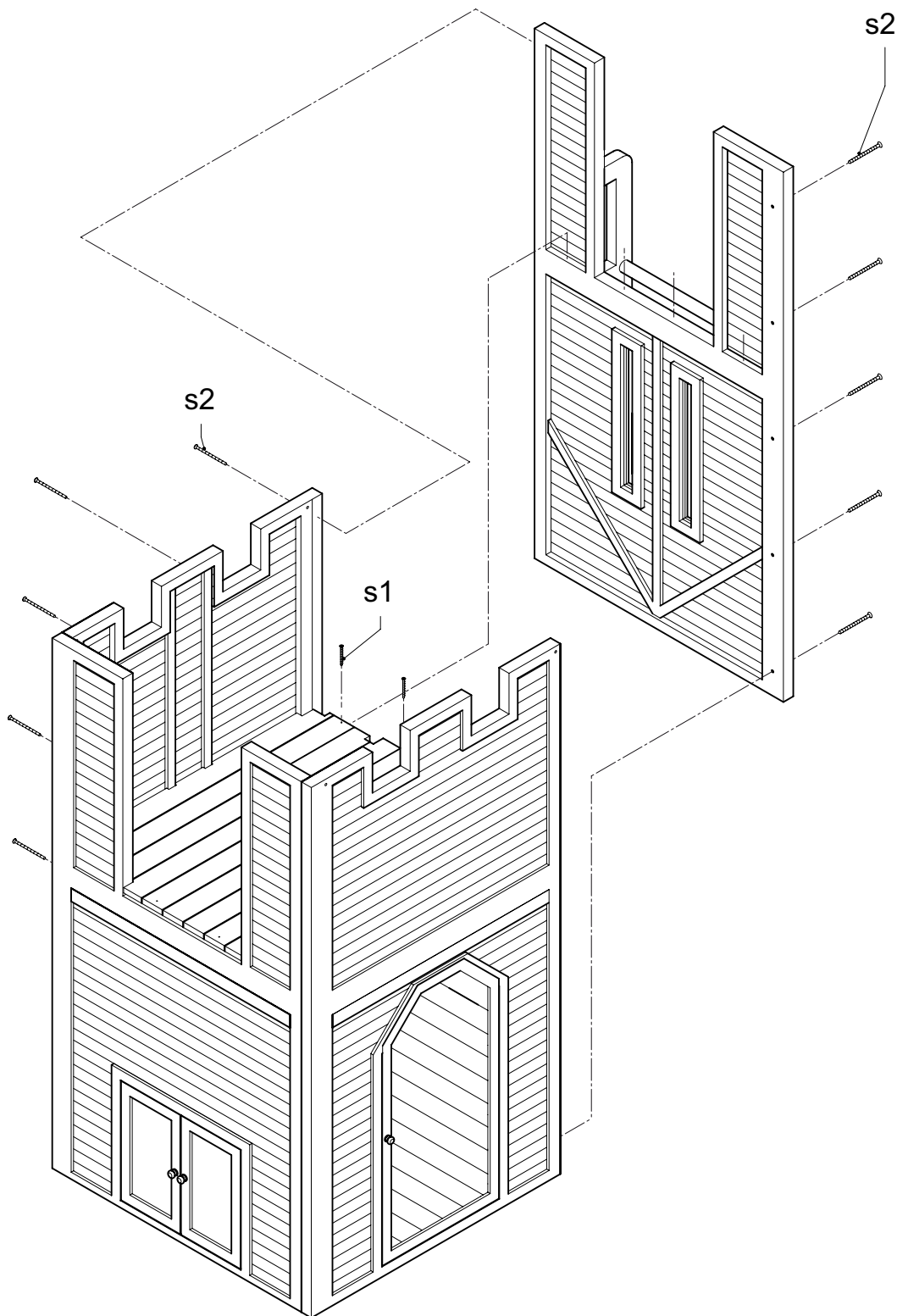
A030.126.00

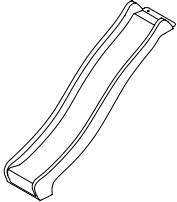
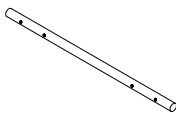

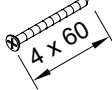
 11	 12	2x	 13	2x	 s2	14x
---	---	----	---	----	--	-----

A030.033.00 + A030.126.00

